

High Temperature Titanium-Water and Monel-Water Heat Pipes

William G. Anderson*, Peter M. Dussinger†, Richard W. Bonner‡, and David B. Sarraf§
Advanced Cooling Technologies, Inc., Lancaster, PA 17601

Space nuclear systems require large area radiators to reject the unconverted heat to space. System optimizations with Brayton cycles lead to radiators with radiator temperatures in the 400 to 550 K range. To date, nearly all space radiator systems have used aluminum/ammonia heat pipes but these components cannot function at the required temperatures. Titanium-water and Monel-water heat pipes will operate in the temperature range, but titanium and Monel cannot be extruded in the same way as aluminum to form grooved heat pipes for space radiators. A method has been developed to form heat pipes in these materials. Grooves are machined into a flat plate, than the plate is bent and welded to form a heat pipe with grooves. Titanium-water heat pipes with a 1.3 cm O.D. and a length of roughly one meter have been fabricated with 3 different groove designs. The heat pipes carried 300-400 W at temperatures of 425 and 475 K. Water life test pipes have been fabricated with commercially pure (CP) titanium, Monel K-500, Monel 400, and various titanium alloys. CP-Ti and Monel pipes now have 17,400 hours of operation. These pipes continue to operate successfully, with a small amount of gas generation in the CP-Ti pipes. Life test pipes with titanium alloys are also underway, with between 4,000 and 9,000 hours of operation.

I. Introduction

Space nuclear power systems require a large radiator to dissipate the waste heat generated during the thermal-to-electric conversion process. System optimizations with Brayton cycles lead to radiators with radiator temperatures in the 400 to 550 K range and minimum mass. Mason (2003) discusses the overall system concept. Siamidis et al. (2004) describe a typical radiator design for a Brayton system. To date, nearly all space radiator systems have used grooved aluminum/ammonia heat pipes or loop heat pipes, which can operate at temperatures up to about 325 K.

At higher temperatures, a different working fluid, wick, and envelope material are required. At temperatures up to 550 K, water has been selected at the heat pipe working fluid, since it has fluid properties that are superior to other working fluid candidates.

A. Materials Selection

Copper is the traditional envelope and wick material for water at temperatures below about 425 K, with a large experience base. At higher temperatures, where the vapor pressure of water increases rapidly, copper is not acceptable for the envelope material, due to its relatively high mass and low strength.

Anderson, Dussinger, and Sarraf (2006a) reviewed previous work and selected titanium, Monel 400, and Monel K-500 as potential heat pipe materials for high temperature water heat pipes. For the solid grooved heat pipes, titanium was selected over Monel for two reasons. First, for a given wick design, titanium heat pipes have a lower mass than the equivalent Monel 400 or K-500 pipes. Second, titanium has been used with a large number of working fluids, so a grooved titanium heat pipe could be used over a wide range of temperatures by varying the working fluid. Titanium has been used in heat pipes with the following fluids:

* Group Leader, Aerospace Group, 1046 New Holland Pike, AIAA Member.

† Manager, Custom Products, 1046 New Holland Pike.

‡ Engineer, 1046 New Holland Pike.

§ Senior Engineer, Aerospace Group, 1046 New Holland Pike, AIAA Member.

- Sodium (Anderson, Dussinger, and Sarraf, 2006b)
- Potassium (Lundberg, 1984, Sena and Merrigan, 1989)
- Cesium (Hartenstine and Bogart, 1990)
- Dowtherm A (Heine, Groll, and Brost, 1984, Groll, 1989)
- Toluene (Heine, Groll, and Brost, 1984, Groll, 1989)
- Water (Heine, Groll, and Brost, 1984, Groll, 1989), Antoniak et al., 1991, Anderson, Dussinger, and Sarraf, 2006a)
- Ammonia (Ishizuka, Sasaki, and Miyazaki 1985)
- Nitrogen (Swanson et al., 1995)

and in loop heat pipes with cesium (Anderson, Dussinger, and Sarraf, 2006b).

Table 1. Heat Pipe Design Requirements.

Working Fluid	Water
Nominal Operating Temperature	500K (227°C)
Operating Temperature Range	310K to 550K (37 to 277°C)
Heat Pipe Heat Transfer Capability	Maximize at 500K
Heat Pipe Outer Diameter	1.27 cm (0.50")
Heat Pipe Evaporator Length	25 cm (9.84")
Heat Pipe Condenser Length	90 cm (35.43")
Heat Pipe Mass	Minimize
Wick Structure Type & Material	Solid Titanium Axial Grooves
Heat Pipe Closure	Titanium Swagelok Bellows Valve

B. Design Requirements

Design requirements for the heat pipes are shown in Table 1. The dimensions and power are typical for heat pipes in optimized space nuclear radiator designs for this temperature range. The heat pipes are longer than 1 meter. For long heat pipes, there are basically three different wick designs that can carry power:

1. Slab wicks, where most of the heat pipe interior is filled with a high permeability screen or other wick,
2. Arterial wicks, where most of the flow between the evaporator and condenser is through one or more arteries, with wicks in the condenser and evaporator to distribute and collect the fluid, and
3. Grooved wicks.

For space applications, slab wicks are significantly heavier than the other designs, so are generally not used. One potential use is in hybrid heat pipes, with a slab wick in the evaporator (allowing higher heat fluxes), and a different wick in the condenser (Anderson, Dussinger, and Sarraf, 2006a)

An arterial wick design was considered and rejected. In our experience, arterial pipes work well in alkali metal systems, due in part to the fact that alkali metals generally require a very high superheat before boiling. Arterial pipes with water or other fluids are more difficult to keep primed. This is especially true in a space nuclear system, where radiation can generate gas in the heat pipe arteries.

Because of potential problems with the other two designs, a grooved wick was selected. Grooved wicks are typically used in space applications, due to their inherent simplicity of design and reproducible behavior.

II. Solid Groove Titanium Heat Pipe Fabrication

Axial grooved heat pipes, particularly aluminum extrusions using ammonia as the working fluid, are a standard, well-established technology. Aluminum extrusion technology is developed to the point that precision axial grooves can be formed directly on the inner diameter of aluminum tubes. For small diameter tubing, 1.27 cm to 2.54 cm, the tolerances for groove width, depth, and corner radii can be held to one-thousandth of an inch (0.025 mm) or better. Many aluminum ammonia extrusions have been made over the past 20 to 30 years that have resulted in highly successful aluminum/ammonia heat pipes.

Unlike aluminum which melts at approximately 660°C, making it relatively easy to extrude through conventional steel dies, titanium melts at 1660°C, above the melting point of steel and high temperature superalloys. Titanium has been extruded into near net shape structural components like channel and angle; however, precision axial groove

formation on the inside of a small diameter, thin walled tube is currently well outside the capabilities of titanium extruders.

The method used to manufacture the solid grooved heat pipes has the following steps:

1. Machine the axial grooves into a relatively thick, flat titanium plate. A typical machined flat plate is shown to the left in figure
2. Using a combination of heat, mandrels, rollers, and other custom forming tools, form the machined plate into a cylindrical tube.
3. Electron beam weld the axial butt joint seam; see the right side of Figure 1.
4. Straighten the welded tube.
5. Roll and grind the welded cylinder to the final outer diameter.
6. Machine end cap details and weld end caps.

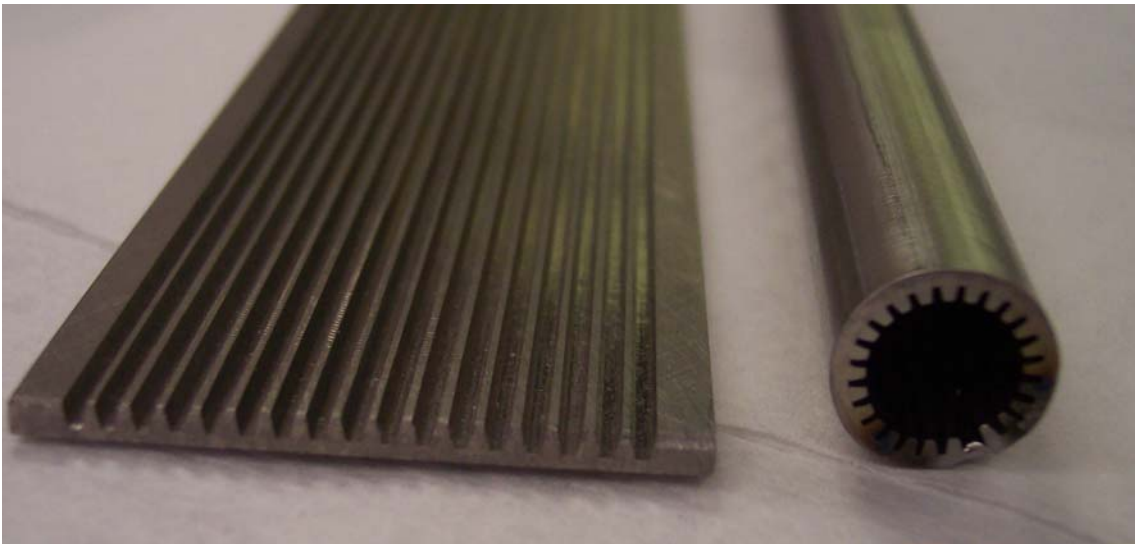

Figure 1. The solid groove heat pipes are fabricated from a flat plate.

III. Heat Pipe Design and Groove Geometry Selection

The following principals and constraints were applied to select the groove geometries:

- Maximize performance at 500K.
- Calculated evaporator ΔT must be less than 10K.
- Groove base width must be greater than or equal to groove width at opening to prevent freeze-thaw damage (geometry cannot “lock in” the ice).

Maximizing performance at 500K is fairly straightforward. This is essentially a capillary limit problem, and various geometry combinations were evaluated to select the highest performance geometry when operated at 500K. The groove geometry has the following constraints:

- Maximizing the number of grooves will result in the highest performance for a given groove geometry. The limit is the manufacturability and stability of the thin land that is left between each machined groove. For practical purposes, the minimum land thickness was set at 0.51 mm (0.020 in.) at the thinnest location.
- Minimizing the groove opening results in the highest capillary pumping pressure and the highest performance for a given groove geometry. The limit is once again the manufacturability of the formed tube. Machining and forming will likely result in a slightly non-uniform groove opening as a function of circumferential position. Closed grooves will be rendered useless because no fluid can enter or exit. Therefore, for practical purposes, the minimum groove opening was set at 0.51 mm (0.020”).
- Maximizing the groove depth will result in the highest performance for a given groove geometry. The limit is both manufacturability and ΔT . Assuming the two constraints listed above, the manufacturability is not an issue. The resulting aspect ratios of depth to width are typically no greater than 3:1. What does come

into play is the increasing ΔT in the evaporator section. As the groove depth increases the power capability increases. This results in a corresponding rapidly increasing ΔT because both the conduction resistance and the heat flux are increasing. For this reason, the calculated ΔT in the evaporator was (somewhat arbitrarily) limited to 10K.

- The shape of the groove has an effect on the freeze/thaw tolerance of the axial groove heat pipe design. Although groove geometries with larger width at the base of the groove versus the groove opening typically result in higher performance, this geometry tends to form a “locked in” triangular shape that will trap ice during freezing and will likely result in physical deformation after repeated freeze-thaw cycles. Therefore, the groove width at the base must be equal to or smaller than the groove width at the opening. This will result in a shape that will allow ice formation to expand without constraint into the empty vapor space allowing for numerous freeze-thaw cycles without damage.

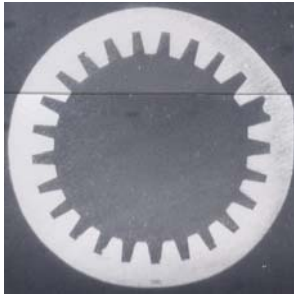

**.020" x .040" Groove
23 Grooves**

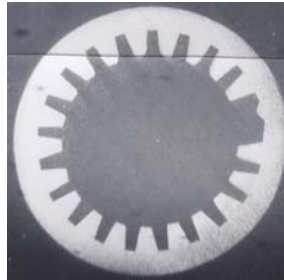

**.025" x .050" Groove
19 Grooves**

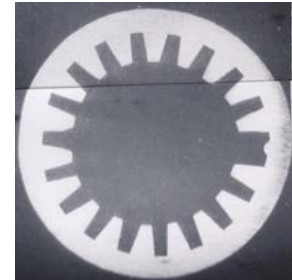

**.030" x .060" Groove
17 Grooves**

Figure 2. Heat pipes were fabricated with three different groove dimensions: 23 grooves, 0.51 mm x 1.02 mm (0.020" x 0.040"), 19 grooves, 0.64 mm x 1.27 mm, and 17 grooves, 0.76 mm x 1.52 mm.

Based on these assumptions and manufacturing constraints, heat pipes with three different groove designs were fabricated, see Figure 2. The pictures above are microphotographs of the as formed axial grooved structures. There are several items to note. One, the electron beam welds are full penetration and result in a local wall thickness greater than the bulk wall thickness (structurally sound). Two, the grooves are all wider at the inside versus at the wall. This will result in a freeze tolerant geometry that should allow for freezing expanding water to push out into the vapor space without damage. And three, the large groove resulting from the weld and circumference constraint could be designed to have a similar groove geometry as the rest if the circumference is allowed to increase or decrease slightly.

IV. Heat Pipe Testing

C. Test Apparatus

After fabrication, the heat pipes were hydrostatically pressure tested, charged with water, and set up on a test fixture. The heat pipes were fitted with a titanium valve to allow for charging, processing, and subsequent gas sampling if necessary. The test fixture is shown in Figures 3 and 4. The orientation can be adjusted during testing. As shown in Figure 4, four electric heater blocks were used to supply heat to the evaporator. A series of type T thermocouples were spot-welded all along the heat pipe, including in between the heater blocks.

A gas gap calorimeter was used to remove the heat from the condenser. In a gas gap calorimeter, a thin gap is left between the heat pipe and the calorimeter, which is water cooled. A mixture of helium and argon flows very slowly through the gap (the heat removed by the gas flow is negligible). Since helium is roughly ten times more conductive than argon, the conductivity across the gap is varied by changing the helium/argon ratio. This allows the heat pipe power removed from the condenser to be varied, while maintaining the heat pipe at a given temperature. Another advantage of a gas gap calorimeter is that it can be used for heat pipes when the heat pipe temperature is much higher than the cooling fluid temperature. ACT commonly uses this type of condenser to test alkali metal heat pipes in air.

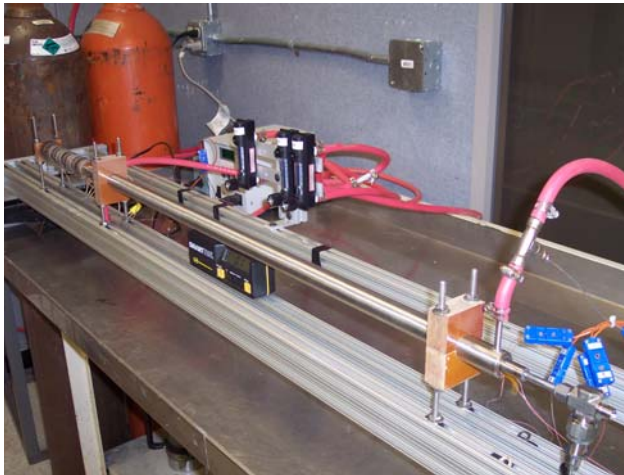

Figure 3. Heat Pipe Test Apparatus uses a gas gap calorimeter to remove heat.

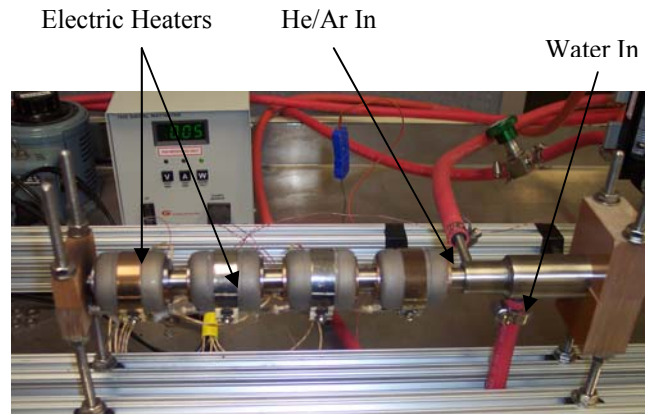

Figure 4. The evaporator has 4 electric heaters, with thermocouples welded in the gaps.

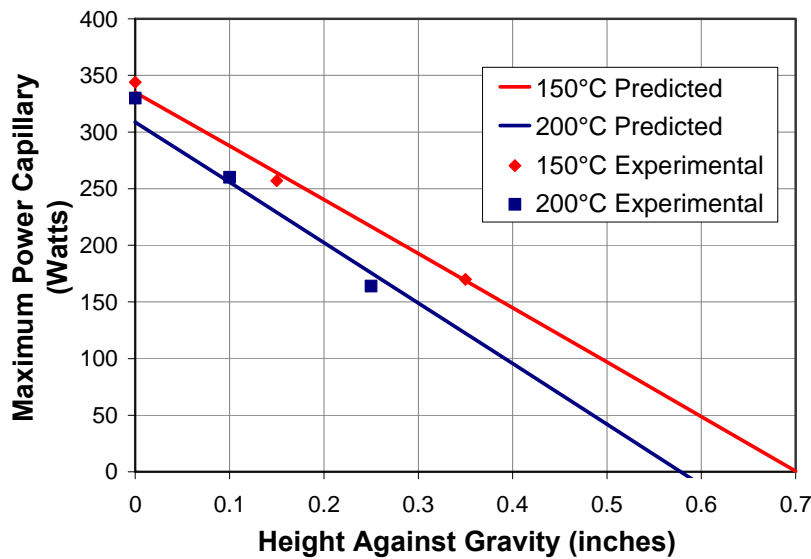

Figure 5. Typical Test Data and extrapolated performance (10°C Delta T). 23 Grooves, 0.51 mm x 1.02 mm (0.020" x 0.040"), Titanium/Water Heat Pipe.

D. Test Results

Typical test results for the heat pipe with 23 grooves, 0.51 mm x 1.02 mm (0.020" by 0.040") are shown in Figure 4, for an evaporator ΔT of 10 °C. Measurements were made at different orientations, while maintaining heat pipe vapor temperatures of 150 °C or 200 °C. Grooved heat pipes are generally tested at different adverse elevations, and the results extrapolated to zero orientation (level). This is done to insure that puddle flow is not occurring. During normal operation, capillary forces in the grooves return liquid. When puddle flow occurs, most of the liquid is returned by gravity, in a puddle at the bottom of the heat pipe.

When capillary forces return all of the flow, the power at zero elevation will be a linear extrapolation of the power at higher elevations. As shown in Figure 5, the increase in power at zero elevation is linear, so puddle flow was not occurring during the tests.

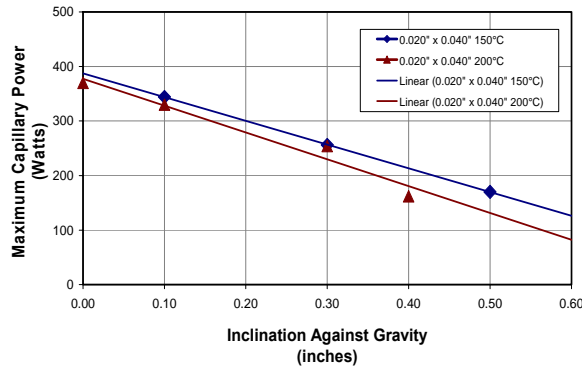

Figure 6. Typical Test Data and linear extrapolation (50 °C Delta T). 23 Grooves, 0.51 mm x 1.02 mm (0.020" x 0.040"), Titanium/Water Heat Pipe.

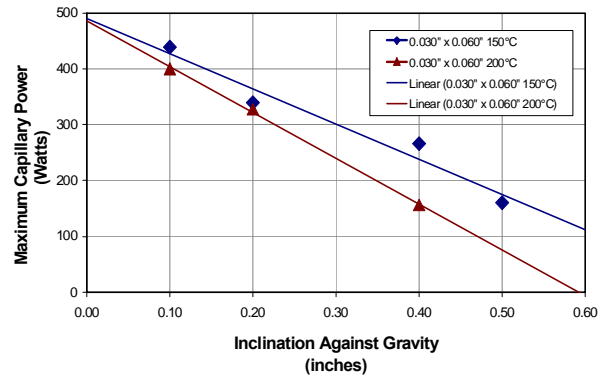

Figure 7. Typical Test Data and linear extrapolation (50 °C Delta T). 17 Grooves, 0.76 mm x 1.52 mm (0.030" x 0.060"), Titanium/Water Heat Pipe.

To measure the powers shown in Figure 5, the heat pipe inclination against gravity was first set. The power was then gradually increased, while the helium/argon mixture was varied to maintain the temperature constant, at either 150 or 200 °C (425 or 475 K). This was the temperature in the heat pipe vapor space, as measured by the thermocouples in the adiabatic section.

Initially, the heat pipe was isothermal at lower powers. As the power was increased, the temperature at the end of the evaporator started to increase above the remaining thermocouples. In most heat pipes with electrical heating, the power at which the evaporator end temperature starts to increase above the remaining thermocouples is considered to be the capillary limit. Dryout will typically occur at higher powers.

However, with the solid groove titanium heat pipes, a steady state would be reached with the evaporator end at a higher temperature than the rest of the heat pipe. Figure 5 shows the power with a 10 °C temperature difference. As shown in Figure 6, the temperature difference for this heat pipe can be increased to more than 50 °C, without dryout occurring. Figure 7 shows a maximum power of almost 500 W for the heat pipe with 17 grooves, 0.76 mm x 1.52 mm (0.030" x 0.060").

We believe that this behavior is due to the lower thermal conductivity of the titanium, ~20 W/m K versus ~ 200 W/m K for aluminum. In a grooved pipe, evaporation normally occurs at the top of the grooves, so heat must be conducted through the fluid and solid metal across the groove height.

E. Future Work

Future work includes the extension of the work to other materials and working fluids. The new fabrication method allows grooved heat pipes to be fabricated in all of the commonly used heat pipe envelope materials, including titanium, Monel, stainless steels, and superalloys. Potentially, it could also be used to fabricate grooved refractory metal heat pipes for high temperature operation. Essentially all of the common heat pipe working fluids, from sodium on down in operating temperature, could be used in grooved heat pipes. ACT plans to examine grooved alkali metal heat pipes, allowing high performance liquid metal heat pipes without arteries.

A second application is for heat pipes operating in the intermediate temperature range, between water at 550 K and below, and the alkali metals at 750 K and above. Life tests with titanium and intermediate temperature fluids are in progress.

Finally, the current grooved heat pipes are fabricated from a single material. Act plans to examine the use of different, higher conductivity grooves in the evaporator.

V. Heat Pipe Life Tests

Anderson, Dussinger, and Sarraf (2006a,b) started a series of life tests with CP-titanium titanium alloys, Monel 400, and Monel K-500. They reviewed previous work, and discussed the life test pipe design and test setup. Figure 8 shows the location of the thermocouples and the heater block. Current life test results will be discussed below.

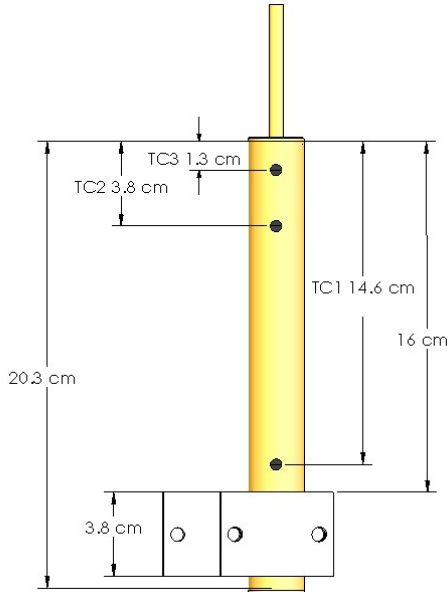

Figure 8. Location of thermocouples and heater block.

The materials under test include:

- Ti CP-2 Heat Pipe, with CP Titanium Screen
- Monel K500 Heat Pipe, with Monel 400 Screen
- Ti Grade 5 Cylinder (6% Aluminum, 4% Vanadium), with CP Titanium Screen
- Ti Grade 7 Cylinder (0.2% Pd), with CP Titanium Screen
- Ti CP-2 Cylinder, with 21S foil and CP Titanium Screen
- Ti Grade 9 cylinder (3% Aluminum, 2.5% Vanadium) with CP Titanium Screen
- Ti CP-2 Heat Pipe, with Sintered Cylindrical Wick
- Monel 400 Heat Pipe, with Monel 400 Screen
- Monel K500 Heat Pipe, with sintered Monel 400 wick
- Monel 400 Heat Pipe, with sintered Monel 400 wick

Table 2 shows the different life test pipes on test. Monel 400 is a solid solution alloy with roughly 63% nickel and 30% copper. It is a single-phase alloy, since the copper and nickel are mutually soluble in all proportions. It can only be hardened by cold working. Monel K500 is a similar nickel-copper alloy, with the addition of small amounts of aluminum and titanium that give greater strength and hardness. The system is age-hardened by heating so that small particles of Ni₃(Ti, Al) are precipitated

throughout the matrix, increasing the strength of the material. The material must be annealed before welding, for ductile welds.

Table 2. High Temperature Titanium/Water and Monel/Water Life Tests.

Quantity	Wall Material	End cap/ Fill Tube	Wick	Operating Temperature	Operating Hours 6 June 2006
4	Monel K 500	Monel 400	200x200 Monel 400 Screen 0.064 mm wire	550 & 500 K	17,376 hours
4	CP-2 Ti	CP-Ti	150x150CP-Ti Screen 0.069 mm wire	550 & 500 K	17,376 hours
4	CP-2 Ti	CP-Ti	Sintered Titanium -35+60 Mesh CP-2	550 K	8,933 hours
2	CP-2 Ti	CP-Ti	100 x100 CP-Ti Screen 0.05 mm wire	550 K	1996/6248 hours
2	CP-2 Ti 21 S Foil Inside	CP-Ti	100 x100 CP-Ti Screen 0.05 mm wire	550 K	8,933 hours
2	Grade 5 Ti	CP-Ti	100 x100 CP-Ti Screen 0.05 mm wire	550 K	8,933 hours
2	Grade 7 Ti	CP-Ti	100 x100 CP-Ti Screen 0.05 mm wire	550 K	8,093 hours
2	Grade 9 Ti	CP-Ti	100 x100 CP-Ti Screen 0.05 mm wire	550 K	4,776 hours
2	Monel 400	Monel 400	120x120 Monel 400 Screen 0.05 mm wire	550K	4,272 hours
2	Monel K 500	Monel 400	120x120 Monel 400 Screen 0.05 mm wire	550K	3,432 hours
2	Monel 400	Monel 400	-100+170 Mesh Monel 400 Powder	550K	2,184 hours
2	Monel K 500	Monel 400	-100+170 Mesh Monel 400 Powder	550K	2,544 hours

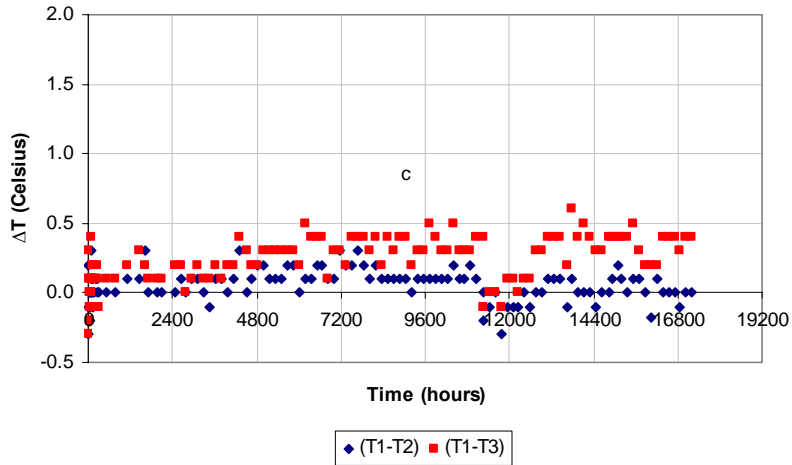

Figure 9. Low Temperature (Non-Condensable Gas) Measurements for Monel /Water Heat Pipe 105, Operating at 500 K.

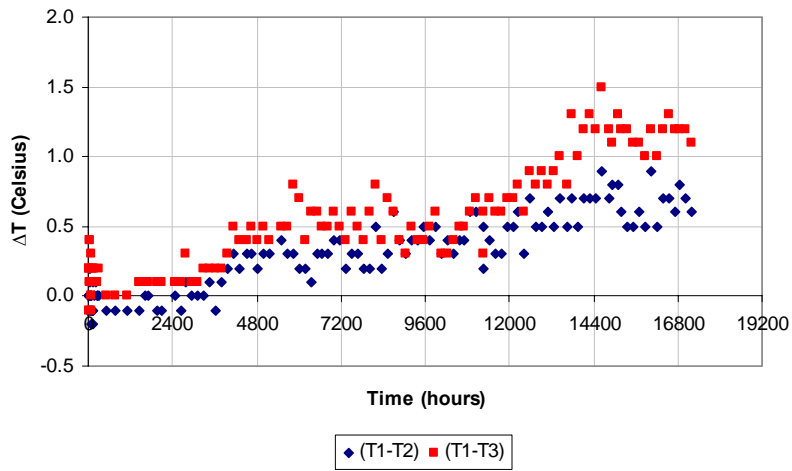

Figure 10. Low Temperature (Non-Condensable Gas) Measurements for Monel /Water Heat Pipe 106, Operating at 550 K.

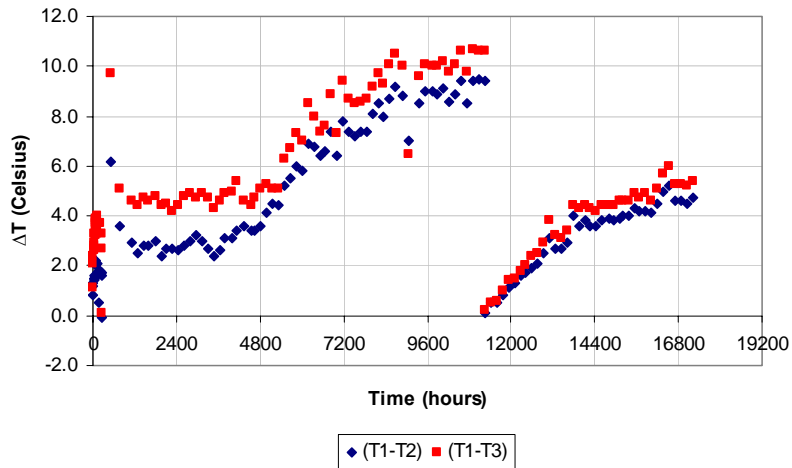

Figure 11. Low Temperature (Non-Condensable Gas) Measurements for CP Ti/Water Heat Pipe 103, Operating at 550 K. Second purge after 11,256 hours of operation.

As shown in Table 2, CP-Titanium heat pipes and Monel K-500 envelope/Monel 400 heat pipes currently have on life test for 17,376 hours. Once a week, the heat pipe temperatures are reduced from the operating temperature to a temperature near 340 K (70°C). Results for the Monel pipes are shown in Figures 9 and 10 for heat pipes operating at 500 and 550 K, respectively. All of the pipes have a low ΔT , indicating that generation of noncondensable gas is not a problem.

Typical results for a CP-Ti pipe are shown in Figure 11. All of the titanium pipes generate gas during their initial operation, as the titanium surfaces are passivated. After about 300 hours of operation, the pipes were burped of their noncondensable gas. As shown in Figure 10, the pipes were relatively gas free until about 5,000 hours of operation, when the amount of gas started slowly increasing. The pipes were burped for a second time after 11,256 hours of operation. After 17,000 hours of operation the gas in the pipe seems to be reaching a steady state.

Figure 12 shows typical behavior for a CP-Ti pipe, with a -35+60 sintered titanium wick. The pipe was purged after 2,837 hours of operation, and still shows only a small amount of additional non-condensable gas generation, after roughly 9,000 hours of operation.

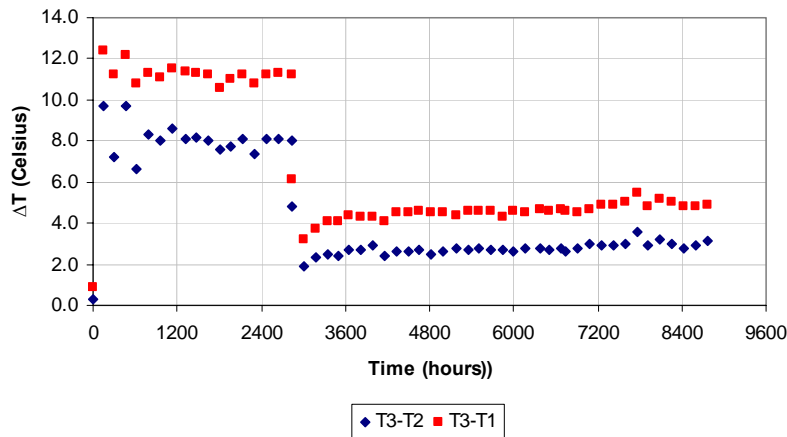

Figure 12. Low Temperature (Non-Condensable Gas) Measurements for CP Titanium Envelope/-35+60 Mesh CP-Titanium Sintered Powder/Water Heat Pipe 4, Operating at 550 K. Purged after 2837 hours of operation.

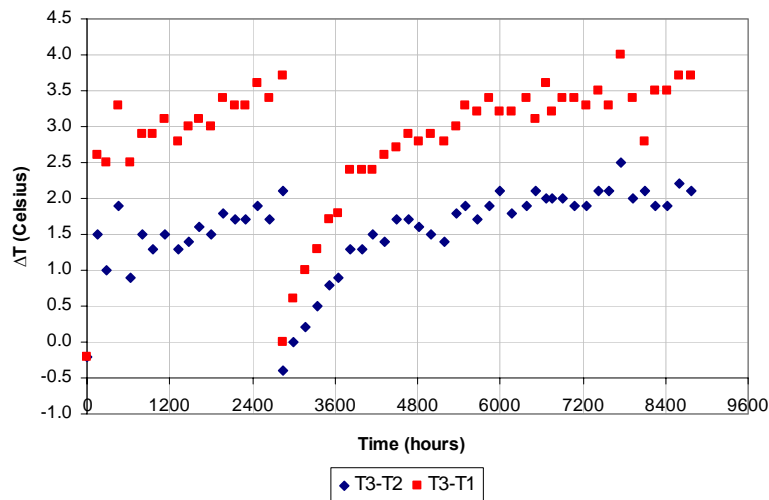

Figure 13. Low Temperature (Non-Condensable Gas) Measurements for Grade 5 Titanium Cylinder/CP-Titanium Screen/Water Heat Pipe 2, Operating at 550 K. Purged after 2837 hours of operation.

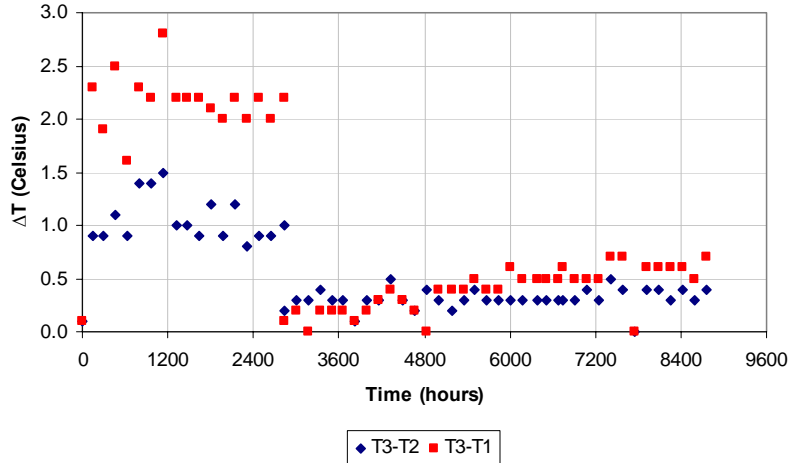

Figure 14. Low Temperature (Non-Condensable Gas) Measurements for Grade 7 Titanium Cylinder/CP-Titanium Screen/Water Heat Pipe 8, Operating at 550 K. Purged after 2837 hours of operation.

Figure 13 and 14 shows life test results for heat pipes with Grade 5 and Grade 7 cylinders, respectively. The remainder of the heat pipe (end caps and fill tubes), and screen wick were fabricated from CP-titanium. These pipes were also purged of non-condensable gas after 2,837 hours of operation. The amount of additional gas generation with the Grade 7 heat pipes has been very low.

Recently, heat pipes with a -100+170 mesh sintered Monel 400 wick, and either a Monel K-500 or a Monel 400 envelope have been put on life test. The results are shown in Figures 15 and 16, respectively. Unlike the screen wick Monel pipes (see figures 9 and 10), these heat pipes show some sign of initial gas generation that appears to have been completed. We plan to purge the pipes in the near future, and then continue the life test.

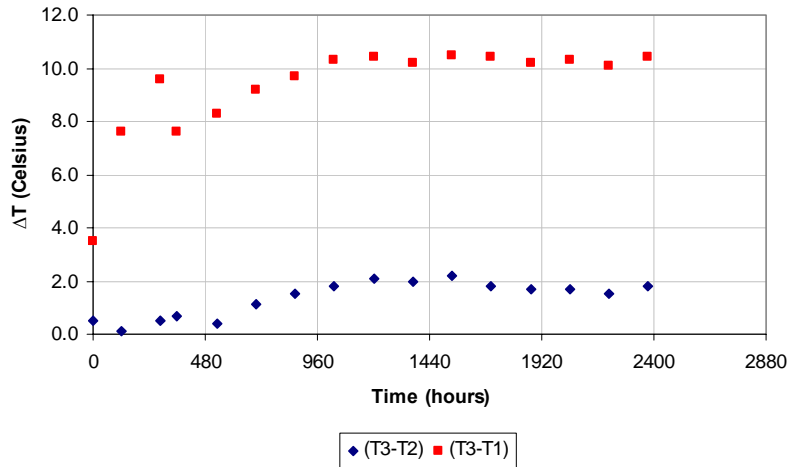

Figure 15. Low Temperature (Non-Condensable Gas) Measurements for Monel K-500 Envelope/Monel 400 Sintered Wick/Water Heat Pipe 20, Operating at 550 K.

VI. Conclusions

Grooved heat pipes have the advantages of simplicity, reliability, and reproducibility. A method was developed to fabricate solid grooved heat pipes in titanium. Heat pipes with three different grooved designs were fabricated and charged with water. The roughly 1.2 m heat pipes carried 300-400 W at temperatures of 425 and 475 K.

Previously, grooved heat pipes were fabricated in aluminum, which is easily extrudable. The new fabrication method allows grooved heat pipes to be fabricated in all of the commonly used heat pipe envelope materials, including titanium, Monel, stainless steels, and superalloys. Potentially, it could also be used to fabricate grooved refractory metal heat pipes for high temperature operation. Essentially all of the common heat pipe working fluids,

from sodium on down in operating temperature, can now be used in grooved heat pipes. Potential applications include alkali metal heat pipe radiators, and well as intermediate temperature heat pipes.

Water life test pipes have been fabricated with commercially pure (CP) titanium, Monel K-500, Monel 400, and various titanium alloys. CP-Ti and Monel pipes now have 17,400 hours of operation. These pipes continue to operate successfully, with a small amount of gas generation in the CP-Ti pipes. Life test pipes with titanium alloys are also underway, with between 4,000 and 9,000 hours of operation.

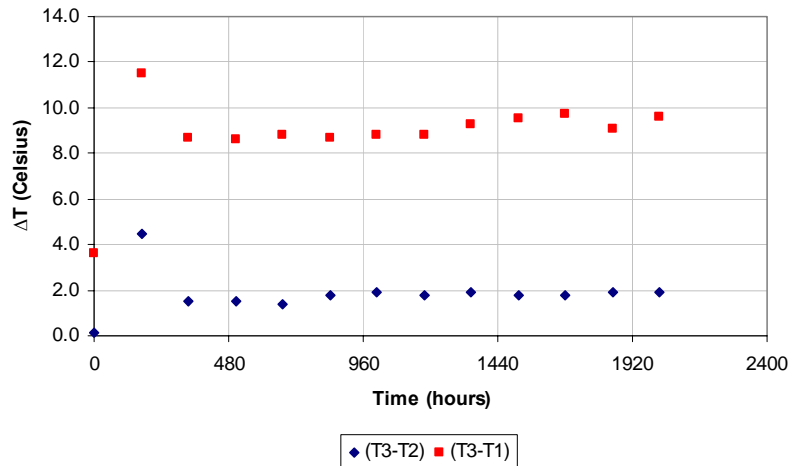

Figure 16. Low Temperature (Non-Condensable Gas) Measurements for Monel 400 Envelope/Monel 400 Sintered Wick/Water Heat Pipe 21, Operating at 550 K.

Acknowledgments

This research was sponsored by NASA Glenn Research Center under Contracts NNC04CA32C, NNC05TA36T, and NNC05CB41C. Duane Beach was the technical monitor.

References

Anderson, W. G., Bonner, R., Hartenstine, J., and Barth, J., "High Temperature Titanium-Water Heat Pipes," Space Technology and Applications International Forum (STAIF-06), edited by M. S. El-Genk, American Institute of Physics, Melville, New York, 2006a.

Anderson, W. G., Dussinger, P., and Sarraf, D., "High Temperature Water Heat Pipe Life Tests," Space Technology and Applications International Forum (STAIF-06), edited by M. S. El-Genk, American Institute of Physics, Melville, New York, 2006b.

Antoniak, Z. I., Webb, B. J., Bates, J. M., and Cooper, M. F., "Construction And Testing of Ceramic Fabric Heat Pipe With Water Working Fluid," proceedings of the 8th Symposium on Space Nuclear Power Systems, 217, American Institute of Physics, Melville, NY, pp. 125-134, Jan. 1991.

Hartenstine, "Conductance Heat Pipes", HTD-Vol. 151, Heat Transfer in Advanced Energy Systems, Editors: R.F. Boehm, and G. Viet, Book No. G00549-1990.

Groll, M., "Heat Pipe Research and Development in Western Europe", Heat Recovery Systems and CHP (Combined Heat & Power), 9(1), pp. 19-66, 1989.

Heine, D., M. Groll, and O. Brost, "Chemical Compatibility and Thermal Stability of Heat Pipe Working Fluids for the Temperature Range 200 °C to 400 °C," 8th ChiSA Congress, Prague, September 3-7, 1984.

Ishizuka, M., Sasaki, T., and Miyazaki, Y., "Development of Titanium Heat Pipes For Use In Space," Proceedings of the Symposium on Mechanics for Space Flight, pp. 157-165, March, 1985.

Locci, I. E., A. Devarakonda, E. H. Copeland, and J. K. Olminsky, "Analytical and Experimental Thermo-Chemical Compatibility Study of Potential Heat Pipe Materials," Proceedings of the 2005 IECEC, San Francisco, CA, August 15-18, 2005.

Locci, I. E., Personal Communication (NASA draft report), 2006.

Lundberg, L. B., "Titanium-potassium heat pipe corrosion studies," International Symposium on High Temperature Corrosion in Energy Systems, Detroit, MI, Sep. 1984.

Sena, J. T., and M. A. Merrigan, "Niobium 1 percent Zirconium/Potassium and Titanium/Potassium Life-Test Heat Pipe Design And Testing," proceedings of the 7th Symposium on Space Nuclear Power Systems, 195, American Institute of Physics, Melville, NY, Jan. 1990.

Swanson, T., Buchko, M., Brennan, P., Bello, M., and Stoyanof, M., "Cryogenic Two-Phase Flight Experiment; Results Overview" proceedings of the 1995 Shuttle Small Payloads Symposium, NASA, pp. 111-123, Baltimore, MD, September 25-28, 1995.