

Loop Heat Pipe for TacSat-4

Peter M. Dussinger, David B. Sarraf, and William G. Anderson

*Advanced Cooling Technologies, Inc.
1046 New Holland Avenue
Lancaster, Pennsylvania 17601
717-295-6052; pete.dussinger@1-ACT.com*

Abstract. The TacSat-4 micro-satellite uses an aluminum/ammonia loop heat pipe (LHP) to transport 700 W of heat from the electronics to two radiator sections. In addition to the thermal requirements, there were additional specifications for the primary and secondary wicks, and the flow balancer between the two LHP condensers. This paper discusses the experimental test rigs designed to verify the LHP performance against these requirements. The measured LHP performance at various operating conditions including start-up, un-balanced condenser heat removal, transient power, high power, and shut-down is discussed.

Keywords: Loop Heat Pipe, LHP, Secondary Wick, Flow Balancer, Satellite Thermal Control

PACS: 44.35.+c, 44.0.+i

INTRODUCTION

TacSat-4 is a tactical micro-satellite that is being built by the Naval Research Laboratory (NRL). The primary goal of the TacSat program is to develop a relatively low cost, quickly deployable, operationally responsive system that moves satellites towards a more operational/tactical level of processes and users. The satellite payload is primarily advanced communications equipment. The satellite will be flown in a highly elliptical orbit and the power level is in the 200 to 700 Watt range.

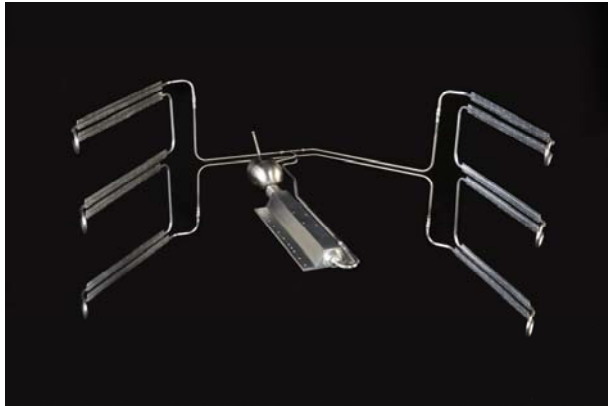

FIGURE 1. Tac-Sat 4 Loop Heat Pipe.

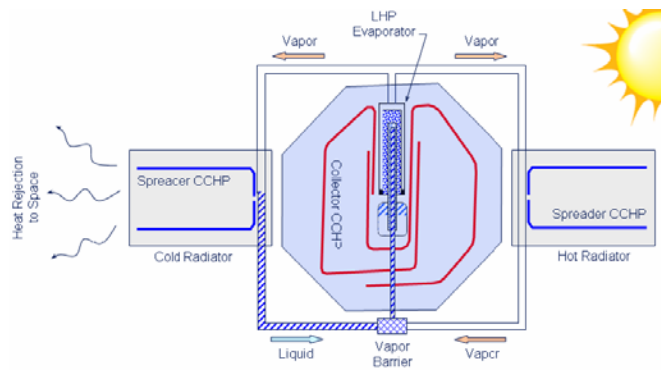

FIGURE 2. Schematic Representation of the TacSat-4 Thermal Control System.

A photograph of the flight quality loop heat pipe for the TacSat-4 thermal control system is shown in Figure 1. It consists of a one evaporator with two parallel condenser sections. The evaporator contains a high performance, sintered nickel primary wick with a robust, screen composite secondary wick. A schematic of the thermal control system is shown in Figure 2. The power dissipating electronics boxes/modules are attached to a honeycomb panel that has two embedded constant conductance heat pipes (CCHPs). The LHP evaporator is attached to the CCHPs and transfers the heat from the CCHPs to one or both of the condensers, depending on the temperature of the

radiators that are attached to the LHP condensers. Each of the two radiator sections is four segments of the octagonal shaped satellite envelope.

TABLE 1. TacSat-4 Loop Heat Pipe Design Requirements.

| Parameter/Description | Quantity/Magnitude |
|---|--|
| Operating Temperature | -20 to +50°C |
| Survival Temperature | -70 to +80°C |
| Working Fluid | High Purity Ammonia |
| Heat Transport Capability | 5 to 700 Watts |
| Effective Thermal Conductance (Pump) | ≥120 W/K at 500 Watts |
| Overall LHP Conductance | ≥70 W/K; 200 to 700 Watts |
| Capillary Pump Length | 30.5 cm (12 inches) |
| Primary Wick Material | Sintered Nickel Powder |
| Primary Wick Pore Size | ≤ 1.5 μm |
| Primary Wick Permeability | ≥ 1.0 x 10 ⁻¹⁴ m ² |
| Primary Wick Thermal Conductivity | ≤ 10 W/m-K |
| Primary Wick Outer Diameter | 2.54 cm (1 inch) |
| Secondary Wick Static Height Capability | ≥ 1.6 cm (0.63 inches) |
| Secondary Wick Transport Capability | ≥ 30.5 W-m (1200 W-in) |
| Secondary Wick Material | Stainless Steel Screen Composite |
| Condenser Geometry | Two (2) Parallel Paths |
| Capillary Flow Balancer Vapor Hold Off | ≥ 1000Pa |
| Capillary Flow Balancer Liquid Delta P | ≤ 1000 Pa at 0.7 grams/sec flow |
| Capillary Pump Material | 6063 Aluminum |
| Compensation Chamber Material | 316 Stainless Steel |
| Transport Line Material | 316 Stainless Steel |
| Condenser Section Material | 6063 Aluminum Extrusion |

The LHP uses ammonia as the working fluid and was designed to transfer up to 700 Watts. The evaporator body and condenser lines are aluminum. The transport lines and compensation chamber are stainless steel. Friction welded bi-metal transition joints are used to couple the stainless steel sections to the aluminum sections. The primary wick is sintered nickel powder and the secondary wick is a stainless steel screen structure. The complete list of design requirements is shown in Table 1. The TacSat-4 LHP was successfully designed, manufactured, tested, and then delivered to NRL in February of 2008. The satellite is scheduled to launch in mid to late 2009.

PRIMARY WICK



FIGURE 3. LHP Primary Wick.

The primary wick for the TacSat-4 LHP was manufactured using sub-micron sized nickel powders. A photograph of two sintered and fully machined primary wicks is shown in Figure 3. The primary wick was tested to determine its porosity, pore radius, and permeability. A sample section of the wick material, taken from one end of the pre-machined wick was also tested for thermal conductivity. Table 2 compares the actual wick properties to the specifications.

TABLE 2. Primary Wick Properties – Specification versus Actual.

| Property | Specification | Actual |
|----------------------|--|--|
| Porosity | n/a | 75% |
| Pore Radius | ≤ 1.5 μm | 1.4 μm |
| Permeability | ≥ 1.0 x 10 ⁻¹⁴ m ² | 2.0 x 10 ⁻¹⁴ m ² |
| Thermal Conductivity | ≤ 10 W/m-K | 5.5 W/m-K |

The wick thermal conductivity test fixture is shown in Figure 4. A known heat load is applied to the wick sample by electrical resistance cartridge heaters embedded in the “hot end” copper rod. The heat removal is accomplished by a water cooled “cold end” copper rod. Thermocouples are installed in the cold and hot rods along the heat flow path. The temperature between the thermocouples, the cross sectional area of the rod, and the thermal

conductivity of the rod material are used to calculate the power being transferred along the length of the rod. Careful evaluation and correction for the interface resistances is factored in to achieve an accurate result.

The wick pore radius test fixture is shown in Figure 5. The wick sample is saturated with methanol, and has a thin layer of methanol above it. The nitrogen pressure in the lower chamber is increased until a bubble breaks through the top of the wick. Pore radius and permeability measurements were made at several times during the manufacturing process. The first measurement is taken using a sample of the sintered blank. The second measurement is taken on the as-machined wick before installation into the pump body. And, the third and final measurement is taken after the wick has been inserted into the pump body and the compensation chamber end seal is completed. In all cases, the wick exceeded the capillary and flow resistance requirements for this application.

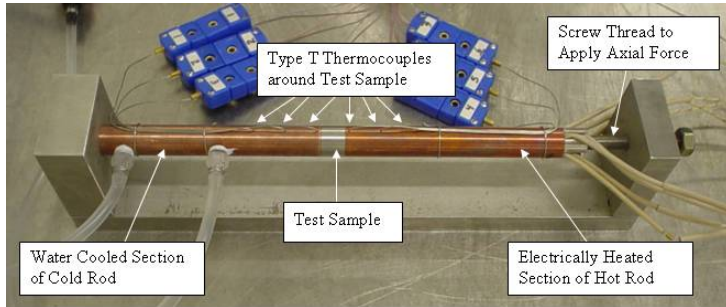

FIGURE 4. Wick Thermal Conductivity Test Fixture.

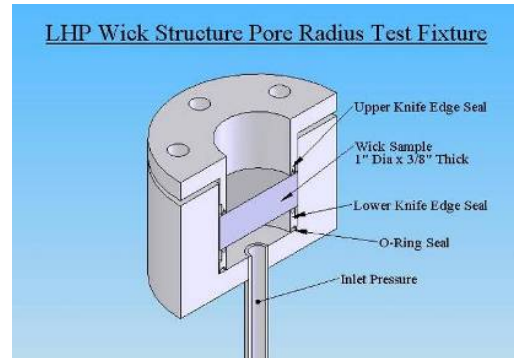

FIGURE 5. Wick Pore Radius Test Fixture.

SECONDARY WICK

Secondary wicks are used to hydraulically link the fluid in the compensation chamber to the primary wick in the evaporator. This is important in both steady state and transient situations. For example, under steady state operating conditions the inner diameter of the primary wick is at a slightly higher temperature than the saturation temperature in the compensation chamber. This causes a small portion of the heat input to the primary wick to be “back conducted” to the compensation chamber, through two-phase evaporation and condensation, similar to a conventional heat pipe. This is often referred to as a “heat leak”. Without a secondary wick to transfer the equivalent amount of working fluid from the compensation chamber back to the primary wick, the primary wick would become starved for fluid and ultimately result in failure (overheating). Certain transient conditions, such as an instantaneous power change and/or rapid condenser temperature change can also cause an imbalance between the liquid returning from the condenser section and the liquid being removed from the primary wick. During these transients, the secondary wick is required to make up the mass flow rate difference by transferring sufficient liquid from the compensation chamber to the primary wick.

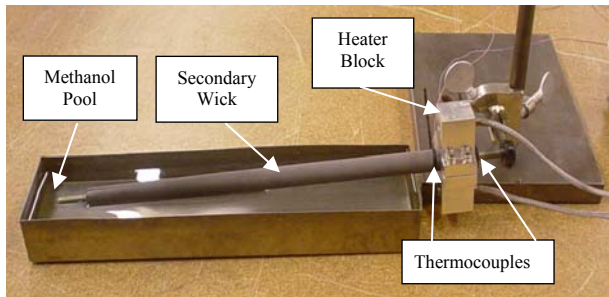

FIGURE 6. Secondary Wick Performance Testing.

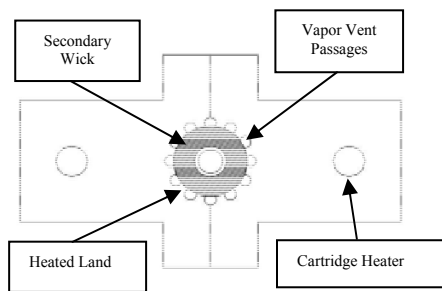

FIGURE 7. Cross-Section of Heater Block Showing Vapor Vents and Heated Lands.

NRL evaluated the potential transient conditions and provided the specification for the LHP secondary wick: 30.5 W-m (1200 W-in) of transport capability at a 2° adverse tilt angle in a 1-g environment. In this application, the primary wick is 30.5cm (12 inches) long and the total wicking or liquid flow length (primary wick + transition + compensation chamber) is approximately 45.7 cm (18 inches) long. Therefore, the secondary wick must be capable of 30.5 W-m against an adverse static height of 1.6 cm

(0.63 inches). The capability of the secondary wick had to be demonstrated prior to final assembly of the evaporator body.

The secondary wick transport capability was measured for both the stand-alone wick, and after the secondary wick was integrated into the primary wick. Figure 6 shows the secondary wick being tested in a stand-alone condition. A custom heater block was designed and built to input heat and allow vapor to escape simultaneously. A cross-sectional view of the heater block is shown in Figure 7. The secondary wick was oriented at a 2° adverse tilt such that only the last bit of the wick was in contact with a pool of methanol. The wick was allowed to wet itself through capillary action. Once the wick was saturated, the heater power was increased stepwise, boiling off methanol that is transported through the wick. The power input and the effective length between the wick-pan interface and the heater was used to calculate the transport capability in Watt-m. Because of the fluid property differences between methanol and ammonia (primarily the liquid viscosity), the results using methanol are approximately 3.3 times lower than what can be expected when using ammonia. The test was halted when a transport capacity of three times the requirement was reached.

Once the potential capability of the secondary wick was demonstrated, the next step was to demonstrate the transport capability as installed into the primary wick. In this configuration, the wick transport capability and the interface or hydraulic connection between the primary and secondary wicks are also demonstrated. Basically, the

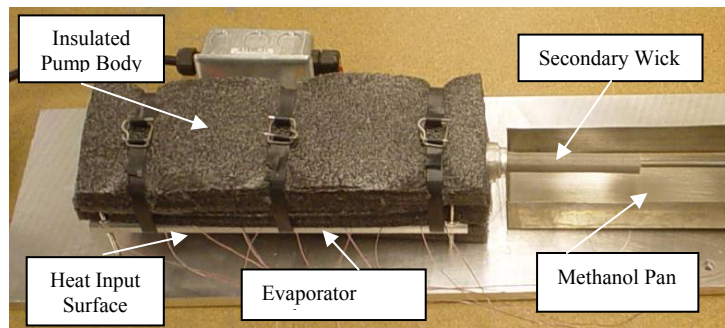

FIGURE 8. In-Situ Secondary Wick Test - Pumping Capacity and Hydraulic Coupling (Temperature Uniformity).

After inserting the secondary wick into the primary wick, the evaporator body was positioned in the 2° adverse tilt orientation and the tip of the secondary wick, which would normally be in the compensation chamber, was allowed to dip slightly into a pool of methanol as shown in Figure 8. A heater, sized to provide uniform coverage, was attached onto the heat input surface of the evaporator; and, a series of thermocouples were attached to the evaporator body along its length.

LHP evaporator is operated under open atmosphere conditions using methanol as the working fluid. The fluid is being supplied to the primary wick through the secondary wick only and the vapor is discharged through the vapor outlet end of the evaporator as it would be in normal service.

After inserting the secondary wick into the primary wick, the evaporator body was positioned in the 2° adverse tilt orientation and the tip of the secondary wick, which would normally be in the compensation chamber, was allowed to dip slightly into a pool of methanol as shown in Figure 8. A heater, sized to provide uniform coverage, was attached onto the heat input surface of the evaporator; and, a series of thermocouples were attached to the evaporator body along its length.

The heater power was increased stepwise as the thermocouples were monitored for uniformity. A non-uniform temperature profile would be a potential indication of a hydraulic coupling flaw between the primary and secondary wicks. The evaporator operated with a temperature uniformity of better than 0.7°C , up to 150 Watts with an effective length of 24cm (9.5 inches), which is a transport capability of 36 W-m (1425 W-in) in methanol. Taking into account the methanol to ammonia fluid properties differences, it is estimated that the secondary wick capability, as installed, is approximately 120 W-m (4700 W-in), which is well in excess of the 30.5 W-m (1200 W-in) required.

PARALLEL CONDENSER FLOW BALANCER

The TacSat-4 Satellite is an octagon shaped structure that is slowly rotating as it makes its way around the highly elliptical orbit. The outer skin also serves as the radiator to dissipate the waste heat to space by radiation. As such, there are times when the solar heating load is quite high on one side of the satellite while the other side is seeing a much colder environment. For this reason, the radiator (or condenser) section of the loop heat pipe is a parallel set of condensers. One condenser path transfers heat to four contiguous panels of the octagonal structure; and, the other condenser path transfers heat to the remaining four contiguous panels. The vapor flowing out of the pump body enters a tee that branches into the two, parallel condenser loops. The loops are connected again through a second tee which collects liquid from the condensers and returns it to the pump body.

If the solar load is particularly high on one of the two LHP condensers, it is possible that the temperature of that condenser will be greater than the LHP operating temperature. In this case, the warm condenser segment will be filled with relatively static superheated ammonia vapor. If this vapor were allowed to mix freely with the sub-

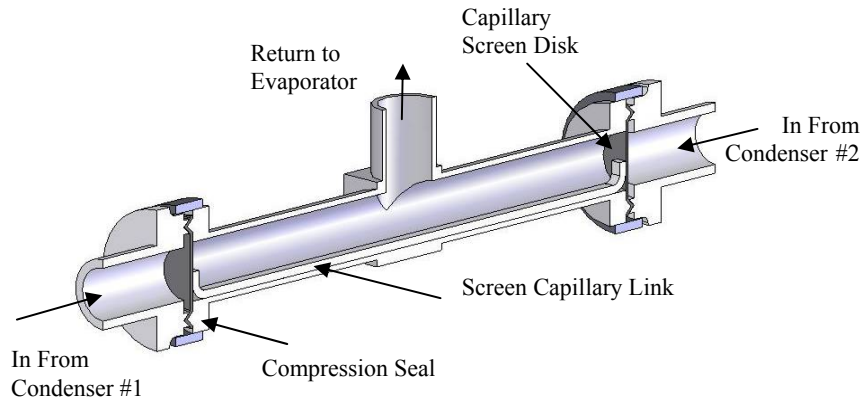

FIGURE 9. LHP Liquid Return Tee Flow Balancer.

cooled liquid returning from the other condenser segment, the superheated vapor would condense into the sub-cooled liquid and this would result in canceling the sub-cooling which would likely cause an uncontrolled rise in the loop temperature. A parallel condenser flow balancer, shown in Figure 9, was designed and installed to prevent the superheated vapor from one condenser segment from mixing with the sub-cooled liquid returning from the other segment.

The flow balancer works by establishing a liquid – vapor interface on a porous membrane.

NRL specified two requirements for the flow balancer. The first requirement was a pressure hold-off capability of greater than 1000Pa. This is set by the expected pressure drops around the loop. The pressure on the vapor side will be higher than the liquid return side by the liquid pressure drop through the active condenser path. If the membrane cannot hold-off this pressure difference, then the vapor will mix with the sub-cooled liquid and result in thermal runaway. The second requirement limited the pressure drop resulting from liquid passing through the membrane. This limit was set at 1000Pa at 0.7 grams per second of ammonia flow. In other words, the active condenser must be able to pass liquid through the membrane that is not being used to hold off vapor pressure without creating a large pressure drop that would adversely affect the loop heat pipe performance.

A composite screen membrane design was used to meet the two requirements. The pore radius of the screen was small enough to hold-off vapor penetration and the membrane was thin enough such that the pressure drop from liquid flow through the membrane was small. In addition to the membrane design, the distance of the membrane relative to the tee intersection is also important. Preventing hot side vapor from canceling the sub-cooling in the liquid return line is key to proper LHP operation. So, thermal models were developed to determine a practical distance (length of tee) such that conduction through the tubing walls and the stagnant liquid slug in the non-flowing side of the tee would be negligible. The selected distance was on the order of 2.5cm.

THERMAL PERFORMANCE TESTING

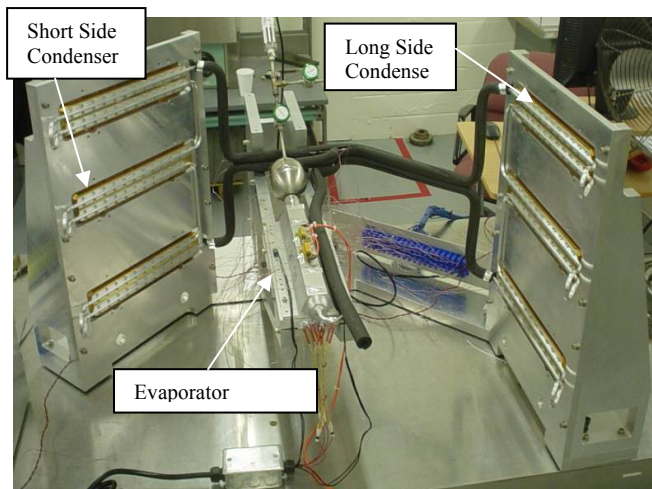

FIGURE 10. LHP Installed on Test Fixture with Insulation Package Removed.

Thermal performance tests were conducted to demonstrate reliable start-up under low power conditions, shut down when minimal heat is applied to the compensation chamber, stable transient response to power and condenser temperature changes, operation at unbalanced condenser temperatures, and the performance limit at high powers. Both the heat transfer rate (power) and the heat conductance of the LHP were of interest. Tests were conducted with the LHP level, and with the LHP tilted at a 2° angle with the compensation chamber below the evaporator. No differences in performance were observed.

The LHP was installed onto an NRL-supplied fixture as shown in the Figure 10. The evaporator was attached to an aluminum block with integral cartridge heaters. The condensers were attached to

copper blocks that were heated or cooled by a liquid or gas passing through channels in the blocks. The temperature of each condenser was independently controlled.

Start-up Testing

The requirement for this LHP was to demonstrate start-up at 10 Watts, 15 Watts, and 50 Watts applied to the evaporator while the condenser temperatures were held at -40°C . Coolant was passed through both condenser blocks until the temperature of the condensers were chilled to -40°C . The evaporator and transport lines remained at room temperature during the chilling operation. This indicates that there was no flow established inside the LHP.

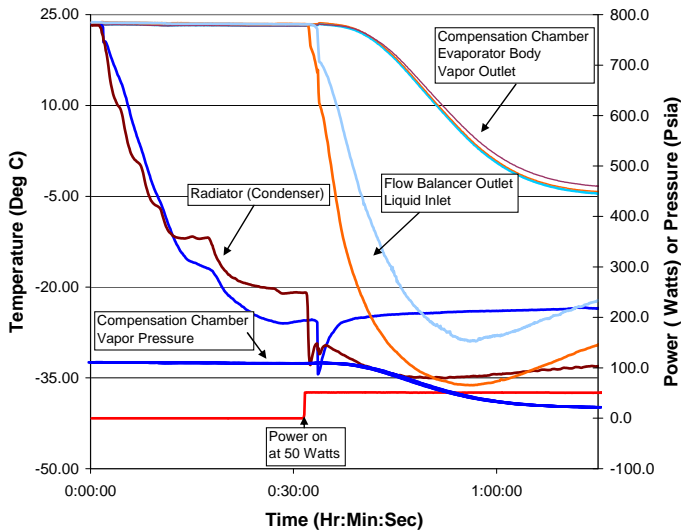

FIGURE 11. 50 Watt LHP Cold Start Test Data.

Once the condensers were stable at -40°C , power was applied to the aluminum heater block attached to the evaporator. Three tests were run at three power levels, 10, 15, and 50 Watts. Figure 11 is a chart of test data collected during a 50 Watt start-up test. The temperature of the flow balancer exit and the liquid return line entering the evaporator body dropped rapidly from room temperature towards the condenser temperature immediately after the power was applied to the evaporator. This indicates that cold fluid in the condensers is starting to flow back to the evaporator body as a result of the low power input. In other words, the LHP has successfully started.

Successful startups were achieved every time and at all three power levels. As can be seen in Figure 10, startup heaters were also installed on the top side of the evaporator body to provide localized, high heat flux startup power. These heaters were never required to start the LHP. It started each and every time with uniform, low power to the entire evaporator surface.

Shut Down Testing

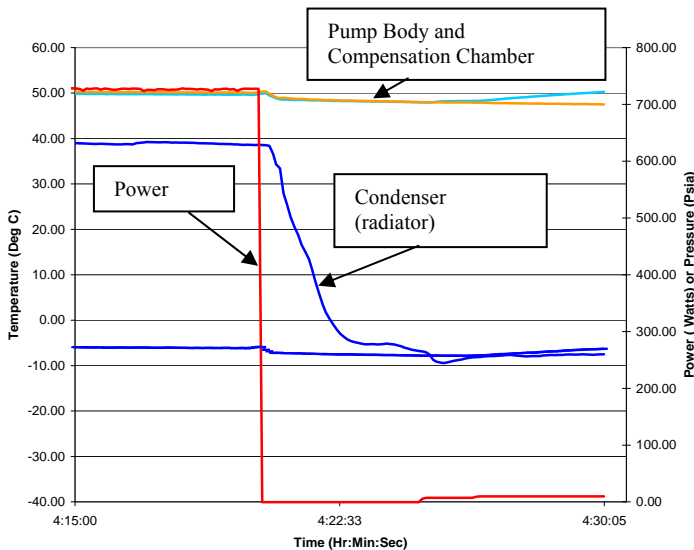

FIGURE 12. Shutdown Test Demonstration: Power is Reduced to Zero and Condenser Temperatures are Simultaneously Lowered from $+40$ to -20°C . The Evaporator Remains at $+50^{\circ}\text{C}$ as Desired.

During the portion of the orbit when the electronics payload is turned off, it is desirable for the loop to stop transferring power to maintain the temperature on the payload deck and minimize the magnitude of the temperature swing of the electronics through an orbit. Typically, a working LHP will continue to transfer power from the evaporator to the condenser, until the evaporator and condenser temperatures are nearly equal. In many applications, this can occur during the coldest portion of the orbit.

In order to prevent the LHP from cooling the payload deck during the zero power portion of the orbit, a small heater, attached to the compensation chamber is activated. The small heater raises the saturation temperature and pressure of the compensation chamber, which

cancel the pressure difference that is required to circulate the sub-cooled liquid from the condenser to the evaporator.

Figure 12 is a plot of test data that demonstrates the ability to shutdown the LHP almost immediately and with a very small heater power. The test data shows how quickly the condenser section drops in temperature to match the environment; while simultaneously, the evaporator retains its heat and stays nearly constant in temperature. The LHP shuts down very quickly with a small heat input of approximately 10 Watts.

Unbalanced Condenser Temperature Testing

As described earlier, the TacSat-4 satellite will be flown in a highly elliptical orbit and the satellite itself will spin slowly about the main axis. This can result in large differences in the condenser panel temperatures. At any

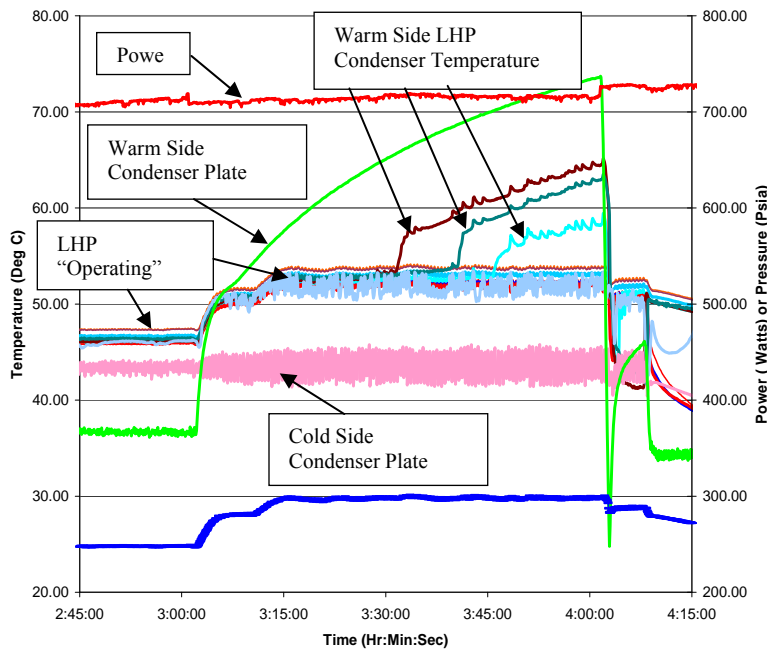

FIGURE 13. Unbalanced Condenser Temperature Testing - One Simulated Radiator Panel is Kept at 40 °C while the Other Panel is Heated Above the Saturation Temperature of the LHP.

sections set at approximately 40 °C. This resulted in steady state operation at approximately 47 °C (“LHP Operating Temperature”) with both condensers operational. At this point, the temperature of one of the two condenser sections was increased, by energizing a heater attached to this condenser section and stopping the flow of coolant to this section.

The “hot side” condenser stopped working almost immediately, as can be seen by the increase in the operating temperatures as shown in Figure 13. The saturation temperature of the loop increased by approximately 6°C and then stabilized. The increase in the loop temperature is expected because one of the two condensers is no longer operational. In other words, the area for condensation has been halved; and therefore, the temperature difference required to transfer 700 Watts increased to compensate. After 45 minutes, the entire “hot side” condenser has been cleared of liquid and the remaining vapor is relatively stagnant and superheated. This can also be seen in Figure 13, where the temperature sensors attached to the “hot side” condenser start to increase significantly above the LHP operating temperature.

During the “hot side” testing, the LHP continues to operate with only one condenser functioning. The operating temperature of the LHP increases slightly because of the loss of heat transfer area; however, the increase in

given time, one set of radiator panels attached to one of the two parallel LHP condensers can be in full solar illumination, while the other set of radiator panels attached to the other parallel LHP condenser can be facing deep space. It is possible that the temperature of the warm condenser will be greater than the LHP operating temperature. In this case, the warm condenser segment will stop rejecting heat and fill with relatively static superheated ammonia vapor. If this vapor were allowed to mix freely with the sub-cooled liquid returning from the other condenser segment, the superheated vapor would condense into the sub-cooled liquid and cancel the sub-cooling, likely causing an uncontrolled rise in the loop temperature.

Tests were conducted to demonstrate this operating case and test the parallel condenser flow balancer under full power conditions. The test was performed by first operating the LHP at 700 Watts with both condenser

temperature is relatively small and the LHP continued stable operation. No failure or thermal runaway was observed. The test demonstrates that the flow balancer is capable of holding off the “hot side” superheated vapor and flow 700 Watts equivalent of ammonia liquid through the “cold side” at a reasonable flow resistance. At the end of the unbalanced condenser temperature testing, the “hot side” condenser was re-activated. The LHP quickly returned to the pre-test steady state condition.

Transient Response Testing

The LHP was tested with two types of transients that have been shown by previous researchers to cause thermal instabilities or failures in LHPs that did not have an adequate secondary wick to hydraulically couple the compensation chamber to the primary wick. The two transients of interest are power cycling and fast condenser temperature changes.

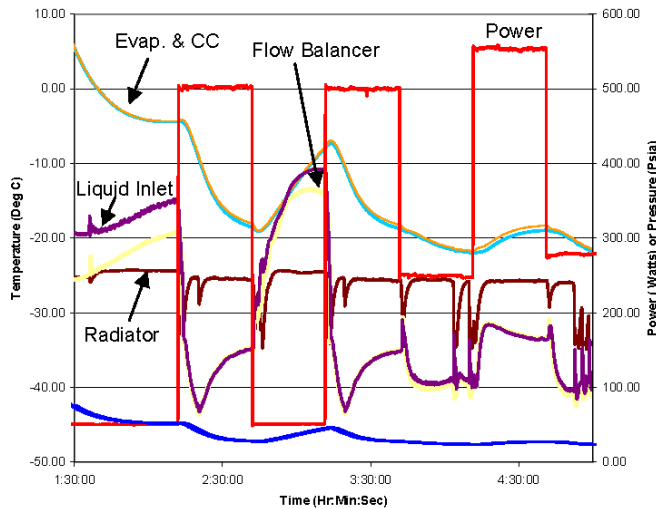

FIGURE 14. Power Cycle Transient Testing; 50W to 500W to 50W to 500W to 250W to 550W to 275W; 30 Minute Dwell at each Power Level; Condenser Plates held at -40°C.

Power cycle transient testing was performed as follows: The LHP was started at 50 Watts with the condenser temperatures set at -40 °C. Every 30 minutes, the input power was changed in the following sequence: 50W to 500W to 50W to 500W to 250W to 550W to 275W. During these power changes, the condenser temperature was held constant at -40 °C. A plot of the power cycle test data is shown in Figure 14. The LHP responded well with no sign of instability or failure.

Condenser temperature cycle transient testing was also performed as follows: The LHP evaporator power input was set constant at 250W, while the condenser temperature was set to -40°C. After steady state was reached, the condenser temperature was increased at a rate of 2°C per minute, until the condenser temperature increased to +20°C. Although the temperature controller was increased at 2°C per minute, the LHP responded slower than this rate of increase because of the thermal mass of the LHP and test fixture. The set point temperature of the condensers was kept at +20°C until the LHP reached a steady state condition. At this point, the condenser temperature was then decreased at a rate of 2°C per minute, until the condenser temperature decreased back to the -40°C starting point. A plot of this data is included as Figure 15. The LHP responded well with no sign of instability or failure during both the increasing and decreasing temperature transients.

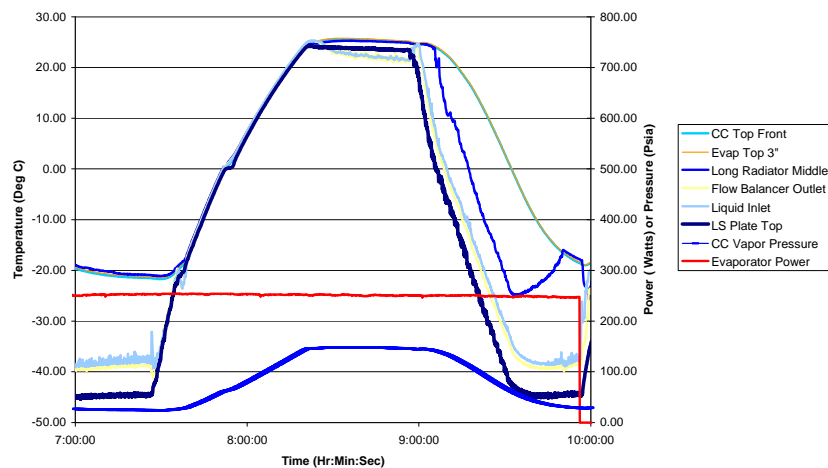

FIGURE 15. Condenser Temperature Transient Test ; -40°C to +20°C to -40°C; Rate of Change 2°C / Minute; Dwell at +20 °C for 20 Minutes.

High Power Limit Testing

High power or maximum power testing was also performed to demonstrate that the LHP could transfer more than the 700 Watts required. The LHP condensers were set to -40°C and the LHP was started at 400 Watts. The power was increased stepwise in 100 Watt increments every 30 minutes up to the heater maximum of 800 Watts. As shown in Figure 16, the LHP is stable and performs as expected up to 800 Watts. Testing above 800 Watts was not performed, so the ultimate limit was not determined.

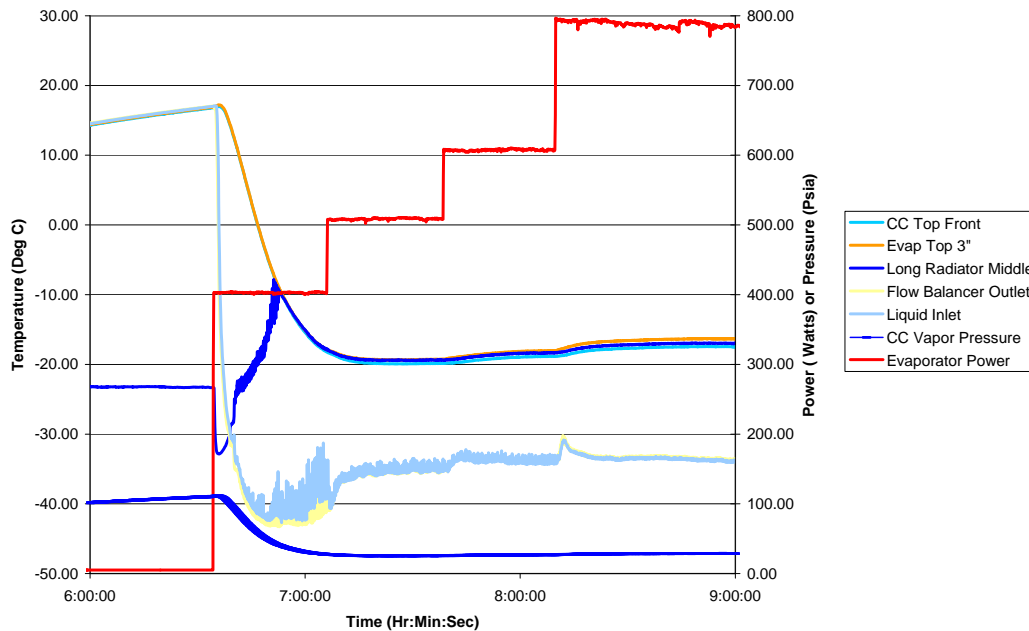

FIGURE 16. High Power Testing - 400 Watt Start Followed by 100 Watt Increases up to 800 Watts.

CONCLUSIONS

The LHP designed and built for the TacSat-4 thermal control system meets and exceeds the requirements and specifications that were developed by the Naval Research Laboratory. The primary and secondary wicks, and the parallel condenser flow balancer were each tested as individual sub-assemblies prior to integration into the final LHP assembly. The new test methods developed, particularly for the secondary wick evaluation, were successful in qualifying the sub-assemblies prior to final assembly and test.

The ground testing including low power starts, shutdown through compensation chamber heating, unbalanced condenser temperature tests, transient testing - both power cycling and condenser temperature changes, and maximum power tests were performed. The LHP performed satisfactorily under all test conditions. The LHP was delivered to NRL in February 2008 for final integration on the TacSat-4 satellite.

ACKNOWLEDGMENTS

This work was performed for the Naval Research Laboratory, Naval Center for Space Technology, Washington DC, under contract number N00173-07-P-2004. Robert Baldauff was the technical manager at NRL. This work was sponsored by the Office of Naval Research. We would like to thank Triem Hoang and Carl Ford, also members of NRL, for their helpful input. The authors would also like to thank the following Advanced Cooling Technologies, Inc. personnel for their contributions: Jared Montgomery, Chris Stover, and Paul Leisey.